

Smith 19" Undermount Basin

Smith 19" Modern Undermount Basin, Oval, Semi-Gloss White
 Smith 19" Modern Undermount Basin, Square, Semi-Gloss White
 Smith 19" Traditional Undermount Basin, Square, Semi-Gloss White
 Smith 19" Traditional Undermount Basin, Oval, Semi-Gloss White

Installation Instructions



Introduction

This product has been fully inspected throughout the production process and only leaves our factory after a 15-step QC process. Carefully remove the basin from the box and check that all parts have been supplied.

Before beginning installation of the basin please check for any damage that may have occurred during transport. **Note: Damage claims cannot be made during or after installation.**

Improper installation shall result in loss of warranty in case of damage caused by impacts or rubbing against rough surfaces.

Prior to installing the basin prepare a connection of water inlet/outlet. The customer may choose the type and location of the faucets, installation instructions should be supplied by the faucet manufacturer. The installation procedure of the basin may differ from that described in the installation instructions, depending on the installation site.

IMPORTANT: Please read these instructions carefully before beginning and retain for future reference.

We do not accept responsibility for any problems that may occur through incorrect installation.

RECOMMENDATIONS:
 It is recommended to remove the protective packaging **after** installation of the basin.

Installation notes

The installation must comply with all plumbing codes including local codes and be installed by a licensed plumbing contractor.

Store the basin in a safe place until installation begins to avoid any damage.

The new basin must be unpacked and inspected before removing the old fixture.

Assemble the basin on a mat to protect against damage to the basin surface.

Avoid getting cement, grit, sand or masonry products on to the surface. Protect and cover the products during the installation period to prevent damage from occurring.

IMPORTANT: Turn off the main water supply before connecting to any existing pipe work or doing any maintenance.

WARNING! Please check for any hidden pipes and cables, electric or otherwise before drilling holes in a wall or floor.

Dimensions

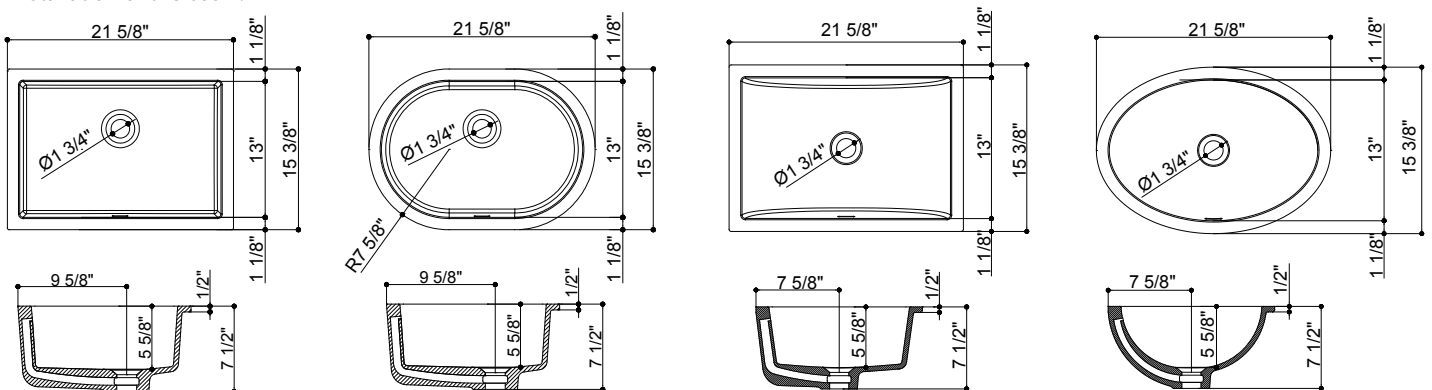

Parts supplied

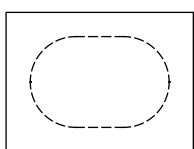

Cut out template

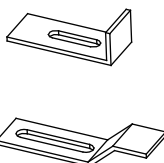

Bracket x 4

Tools required



Tape measure



Safety glasses

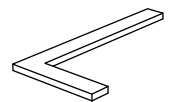

Set square



Pencil

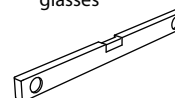

Spirit level

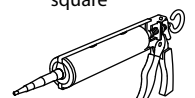

Silicone sealant

1 Installation - carriage

IMPORTANT:

Crosswater London cannot accept responsibility for any injuries caused to those attempting to install this basin without adequate and appropriate tools or resources.

- Remove the basin carefully from the packaging.
- **Do not** drag the basin over rough surfaces or sharp objects. Lift and place the basin into position.
- **Do not** drop the basin!

2 Installation

- This installation guide does not include details of waste connection. Final decision about installation of waste connection should be taken by a suitably qualified contractor.
- Install the waste according to the installation instructions supplied with the waste.
- Place the basin in desired position making sure the waste hole is aligned.
- Apply sealant to the inside edge and place into position.

WARNING: Do NOT overtighten the waste as this may cause long-term damage to the basin.

We recommend using a torque wrench to tighten the waste by using a torque force between 25Nm or 18.5 ft/lb and 50Nm or 36.8 ft/lb.

IMPORTANT:

Basins are not suitable for wall-hung installation without underside support. It is the responsibility of the installer to provide adequate support. Crosswater London cannot be held responsible for inadequate wall-hung installation. Mounting hardware for wall-hung installation not supplied.

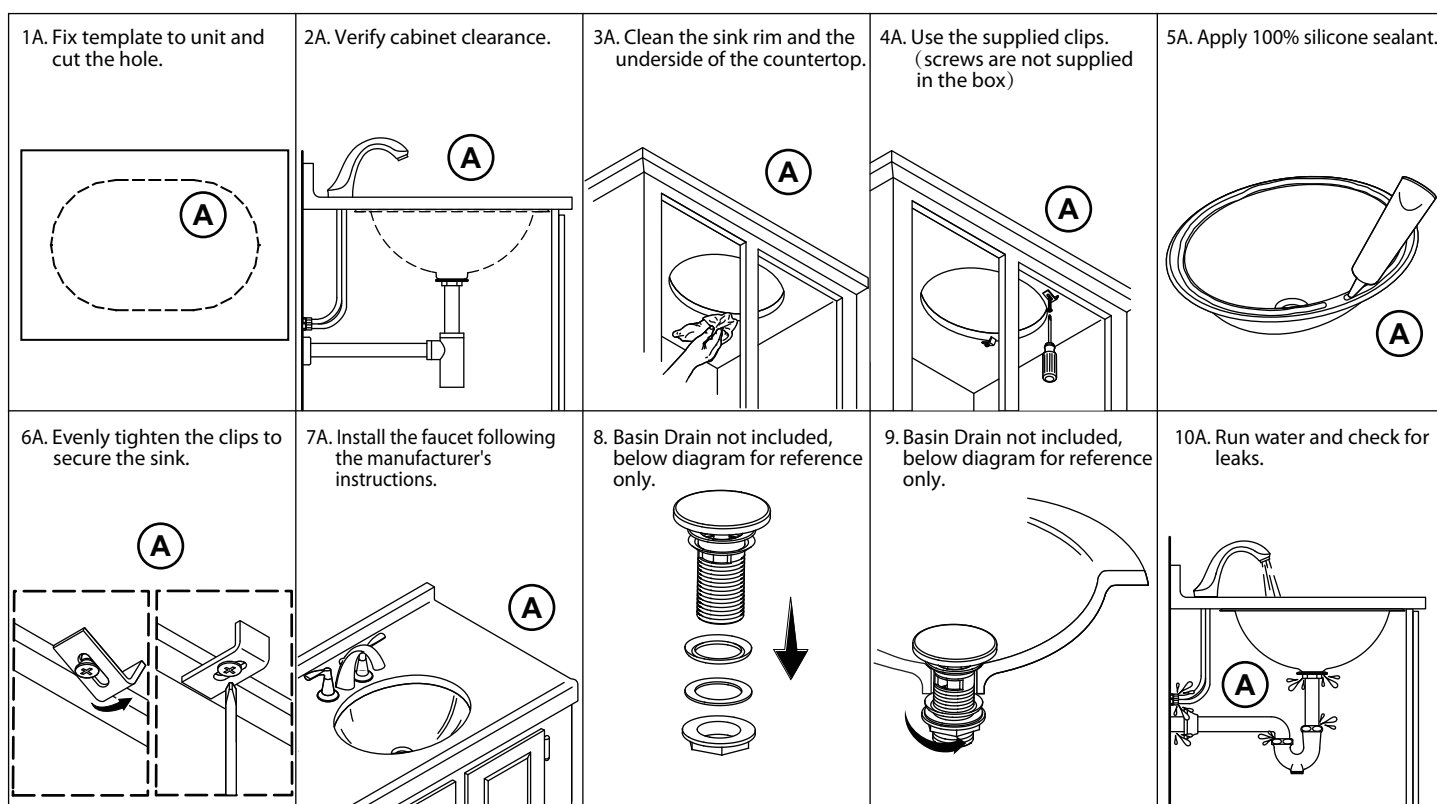

3 Maintenance

Clean the basin regularly with non-abrasive soap and warm water. Fully rinse after cleaning.

While Clearstone is highly stain resistant, it is recommended that water containing additives such as creams, oils or salts is always drained and rinsed immediately after use.

Please note that hair dyes and color cosmetics (eg. mascara, lipstick, face powder) may leave a slight discoloration if not removed immediately.

If any strong chemicals come into contact with the basin, remove and rinse immediately.

Water temperature should not exceed 49°C/120°F.

To remove a fine scratch or a slight mark, use a 1500-grade sandpaper. Gently sand the area with water. For best results, limit sanding to the smallest possible area around the scratch. Re-polish the surface afterwards using a neutral polishing compound or toothpaste. It may be possible to polish very fine scratches away without using abrasive papers: scrub gently with a soft brush or plastic pad (not a metal scouring pad) and a mildly abrasive cream cleaner. Afterwards scrub the whole area with plenty of clean water and re-polish as before.

If the scratch or mark is too deep and cannot be repaired using the above method, it is possible to purchase a repair kit US-CRK. In order to remove the scratches, follow the instructions included with the kit.

Warranty - This **Crosswater London** product is covered by a limited lifetime warranty. For full details, terms and conditions please visit our website.

For further information contact: **Crosswater London**, 393 Fortune Blvd., Milford, MA 01757

www.crosswaterlondon.com

Toll free number: 844-XWATER-1 (844-992-8371) tel: 508-381-0433 fax: 508-381-6068

email: technical@crosswaterlondon.com