

1/2" Three-way Diverter Rough
3DV-RGH

Installation Instructions



For ease of installation you will need:

- To read all the installation instructions completely before beginning.
- To read all warnings, care, and maintenance information.

Before beginning installation, check for any damage that may have occurred during transport.
Note: Damage claims cannot be made during or after installation.

Installation Instructions

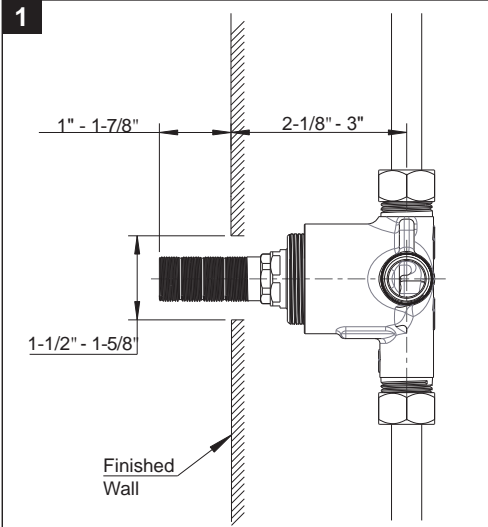

Position valve according to measurements noted in image

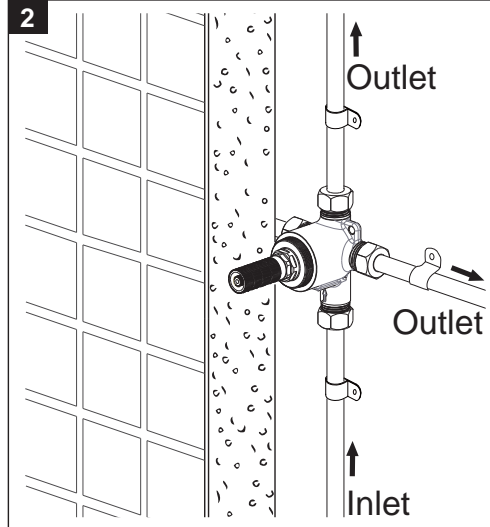

Install the valve with proper fitting or use mounting holes on valve. Support as noted in image. Turn on water supply and inspect for leaks.

Replacement Parts

No.	Description	Part No.
1	Cartridge	5D0001300PL0
2	Stem & Threaded Nipple	9Q1142NT

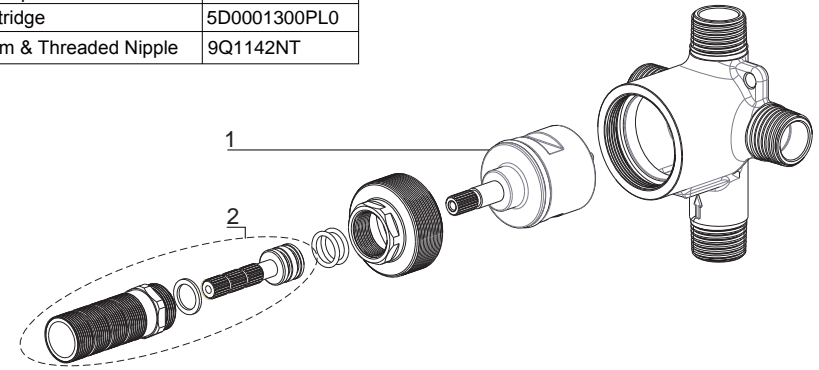

Applicable Standards/Codes

IAPMO certified to meet or exceed the following:

- ASME A112.18.1/CSA B125.1
- Uniform Plumbing Code
- National Plumbing Code of Canada



Installation Dimensions

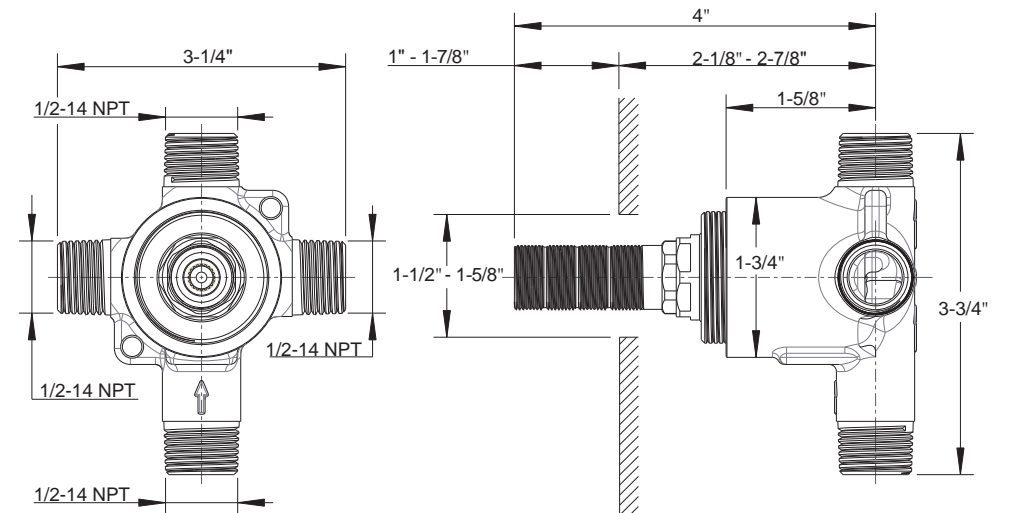

Warranty - This Crosswater London product is covered by a limited lifetime warranty. For full details, terms and conditions visit our website.

For further information contact: **Crosswater London**, 393 Fortune Blvd., Milford, MA 01757
Toll free number: 844-XWATER-1 (844-992-8371) tel: 508-381-0433 fax: 508-381-6068

www.crosswaterlondon.com
email: technical@crosswaterlondon.com