

Leyden Paper Holder / Towel Ring
14-58

Installation Instructions

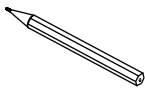

Tools You Will Need



Pencil

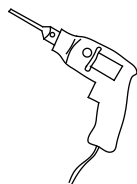

Drill

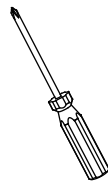

Philips Screwdriver

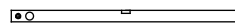

Level

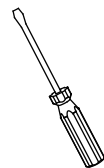

Flat Head Screwdriver

For ease of installation you will need:

- To read the installation instructions completely before beginning.
- To read all warnings, care, and maintenance information.

Before beginning installation, check for any damage that may have occurred during transport.
Note: Damage claims cannot be made during or after installation.

Installation Instructions

1

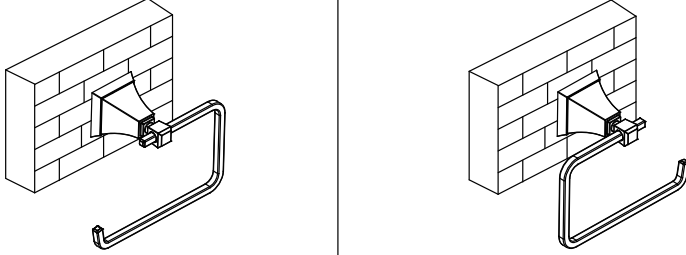

Determine the handing of the accessory. If you would like to flip the bar, please follow steps 2 – 3.

2

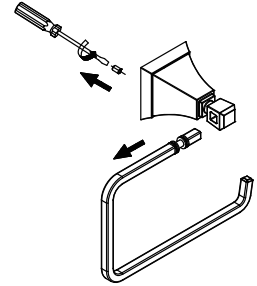

Inside the post, remove the philips head screw with a screw driver and slide out the bar.

3

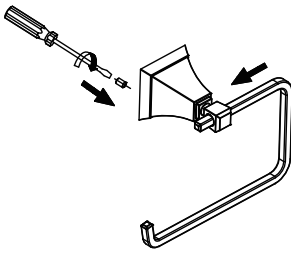

Slide the bar into the post and secure it to the post using the philips head screw.

4

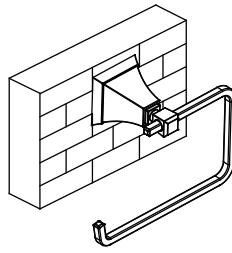

Determine the location of the accessory.

5

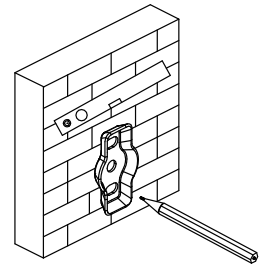

Mark drill holes in desired location.

6

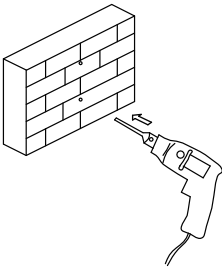

Drill 1/4" holes in marked locations.

7

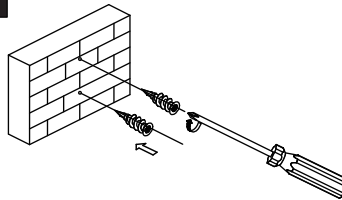

Drive the wall anchors into the drilled holes with a Phillips screwdriver.

8

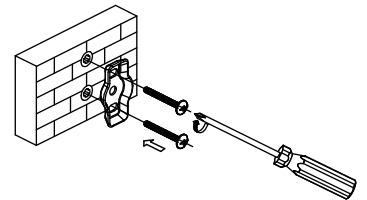

Place the mounting bracket over the wall anchors. Secure it to the wall using the supplied screws.

9

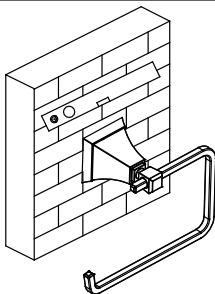

Temporarily place the accessory on the mounting bracket to check alignment. If necessary, loosen the screws and realign the mounting bracket.

10

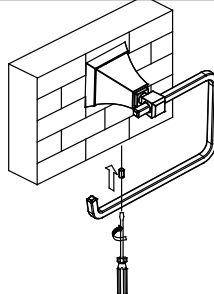

Place accessory on the mounting bracket. Secure it to the wall using the bottom set screw.

Cleaning Instructions

Rinse away any traces of soap and gently dry with a clean, soft cloth after each use. Rinse completely with water and dry any overspray. This will maintain the finish and avoid water spotting.

To remove mineral deposits, use a 50/50 solution of white vinegar and water. Do not allow the solution to soak on the product.

Simichrome Polish® contains a protective film to enhance maintenance and is helpful in preventing water spot buildup. Follow instructions to ensure optimum results.

Never use an abrasive material such as a brush or scouring pad to clean the surface. The use of abrasive cleaners, cleansers or disinfectants will alter the surface finish and void the warranty.

Do not allow certain materials such as toothpaste, cologne, shaving cream, nail polish remover, vinegar, wine, drain and glass cleaners to remain on the surface. Prolonged contact will alter surface finishes and void the warranty.

We DO NOT recommend using any household cleaners as many can cause damage to the finish.

Please see the website for care instructions for specific finishes.

Replacement Parts

No.	Description	Part No.
1	Mounting screws, anchors & plate	00072
2	Philips head screw	06803
3	Set screw	00309
4	Sleeve Assembly	00073

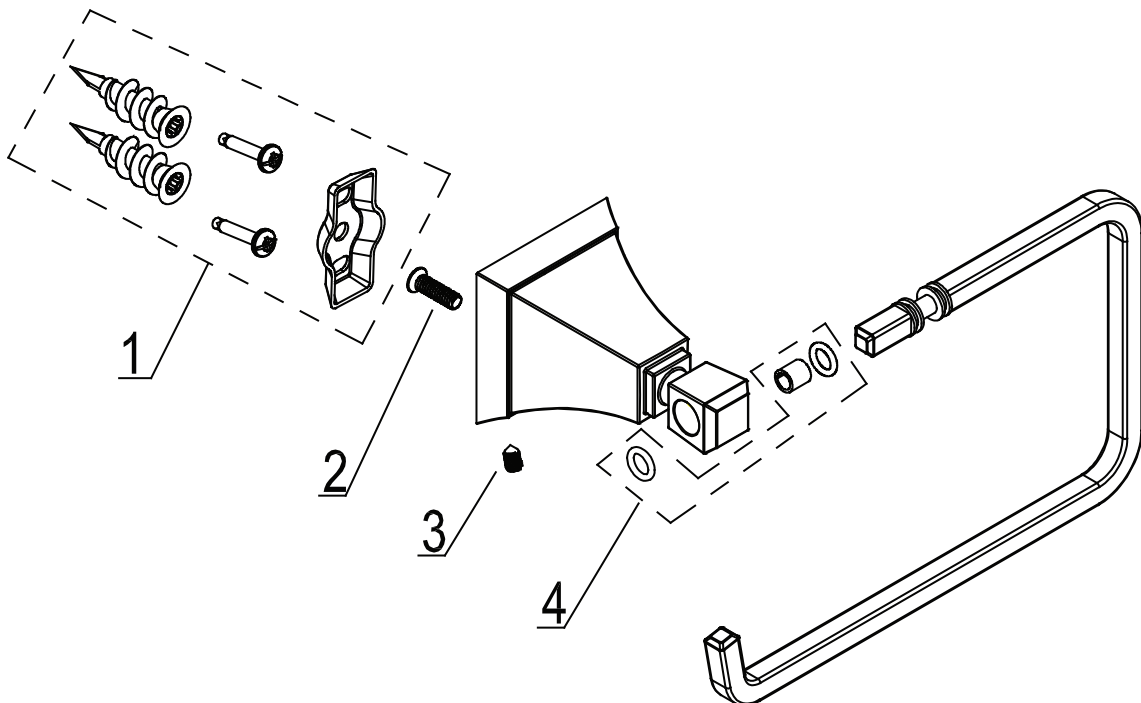

Installation Dimensions

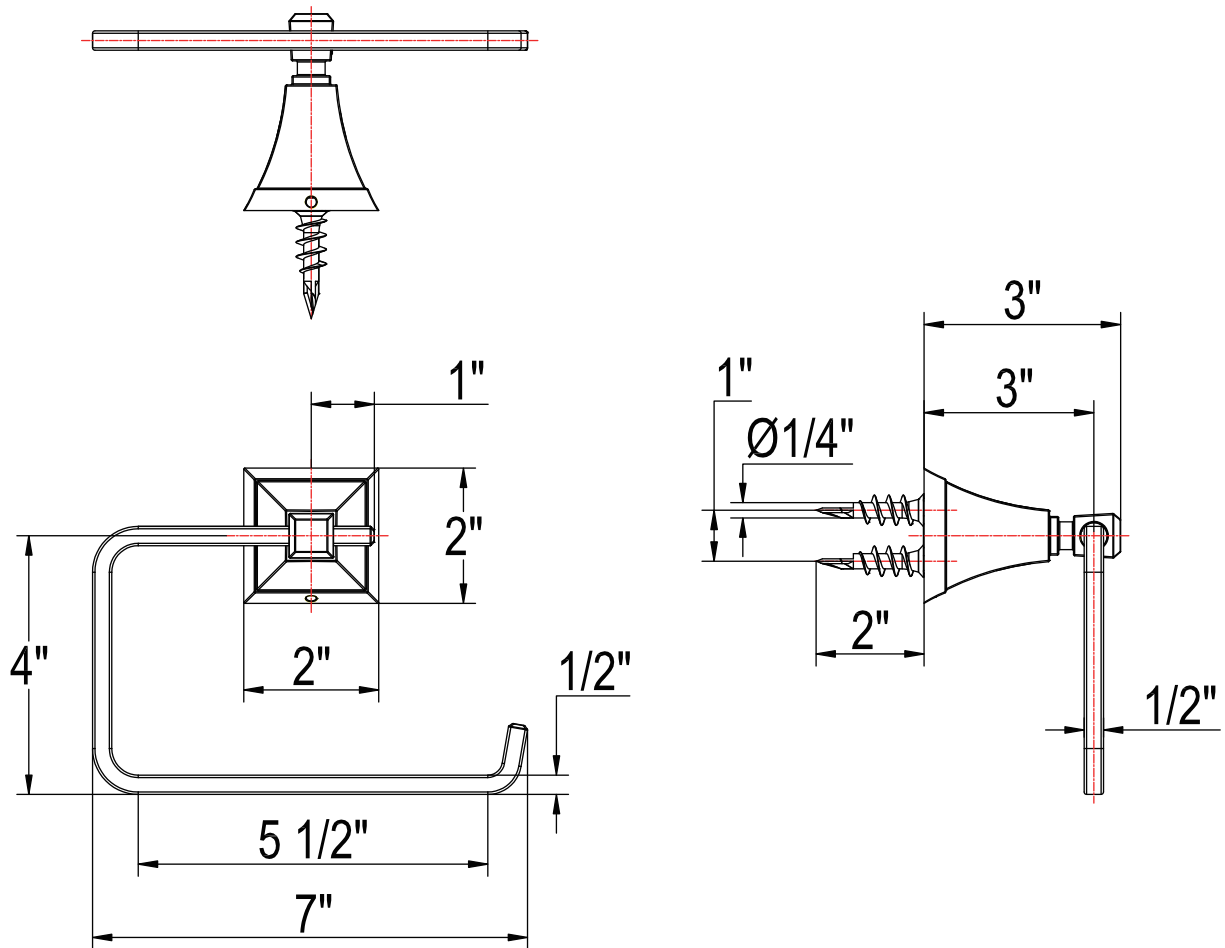

Warranty - This **Crosswater London** product is covered by a limited lifetime warranty. For full details, terms and conditions please visit our website. For further information contact: **Crosswater London**, 393 Fortune Blvd., Milford, MA 01757 www.crosswaterlondon.com
Toll free number: 844-XWATER-1 (844-992-8371) tel: 508-381-0433 fax: 508-381-6068 email: technical@crosswaterlondon.com