

Classic Pedestal Basin US-B15/US-P6

Installation Instructions



Introduction

All parts have been fully inspected throughout the production process and only leave our factory after a 15-step QC process.

Carefully remove the items from the box and check that all parts have been supplied.

Installation should be completed by at least two suitably competent installers.

Before beginning installation, please check for any damage that may have occurred during transport. **Note: Damage claims cannot be made during or after installation.**

Improper installation shall result in loss of warranty in case of damage caused by impacts or rubbing against rough surfaces.

Wall fixings are not supplied. Source fixings which are suitable to the site wall.

IMPORTANT: Please read these instructions carefully before beginning and retain for future reference.

We do not accept responsibility for any problems that may occur through incorrect installation.

Installation notes

The installation must comply with all plumbing codes including local codes and be installed by a licensed plumbing contractor.

Assemble the parts on a mat to protect against scratching the surface.

Avoid getting cement, grit, sand or masonry products on to the surface.

Protect and cover the basin during the installation period to prevent damage from occurring.

IMPORTANT: Turn off the main water supply before connecting to any existing pipework or doing any maintenance.

WARNING! Please check for any hidden pipes and cables, electric or otherwise, before drilling holes in a wall or floor.

Tools required



Tape measure



Safety glasses

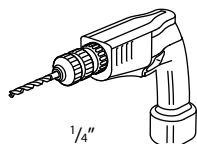

1/4" drill

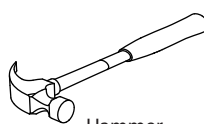

Hammer

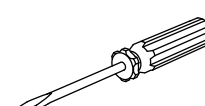

Flat head screwdriver

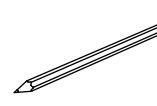

Pencil

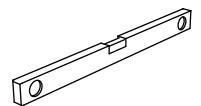

Spirit level

1 Installation - pedestal

- Place the basin in position, against the wall and sitting on top of the pedestal.
- Ensure that the basin is level and mark the required fixing hole locations on the wall, then proceed to drill.
- Using appropriate fixings, attach the basin to the wall securely.

2 Installation

- The pedestal under the basin is for decoration only and is not designed to support the weight of the basin.

Length and width dimensions are measured at the narrowest part of the opening:
L 4-1/2", W 3", H 25-3/4"

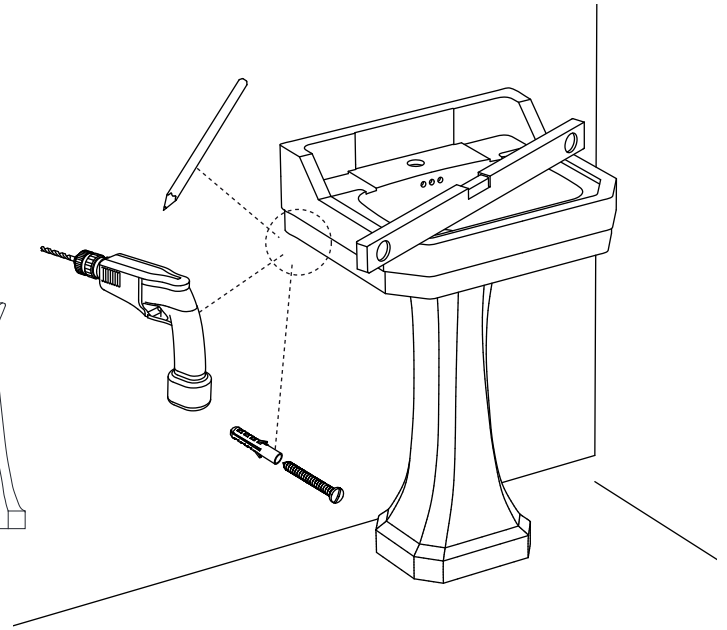
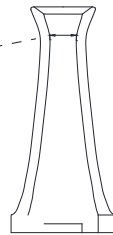

3 Cleaning Instructions

A simple routine of regular care will keep your vitreous china and fireclay products clean and fresh.

Rinse away any traces of soap and gently dry with a clean soft cloth after each use. A mild detergent, warm water and a soft cloth will remove normal dirt and soap accumulations from surfaces. Soft abrasive cleaners may be used on vitreous china and fireclay. Never use abrasive cleaners without water. Do not use caustic cleaners or disinfectants as they can alter the surface finish and void the warranty.

Do not allow certain materials such as toothpaste, cologne, shaving cream, nail polish remover, vinegar, wine, drain and glass cleaners to remain on the surface. Prolonged contact can alter surface finishes and void the warranty.

Warranty - This **Crosswater London** product is covered by a limited lifetime warranty. For full details, terms and conditions please visit our website.

For further information contact: **Crosswater London**, 393 Fortune Blvd., Milford, MA 01757

Toll free number: 844-XWATER-1 (844-992-8371) tel: 508-381-0433 fax: 508-381-6068

www.crosswaterlondon.com

email: technical@crosswaterlondon.com

Issue date: 04092020